



Max Medium Single Emission

LedsC4 Team

Wall fixture IP66 Max Medium Single Emission LED 10.4 LED warm-white 3000K DALI-2 Black 540lm

Technical features

- Luminaire total power: 10.4W
- Real lumens: 540
- Real lm/W: 52
- Correlated Colour Temperature (CCT): LED warm-white 3000K
- Lens / reflector angle: MEDIUM 27°
- UGR: <=16
- Structure material: Aluminium
- Structure finish: Black
- Diffuser material: Glass
- Diffuser finish: Transparent
- Voltage / frequency: 100-277V/50-60Hz
- Dimming protocol: DALI-2
- Power Factor: 0.90
- Useful life: 50,000h L80B20
- Warranty: 5 years
- Resistant to marine environments: Yes
- Easily recyclable luminaire



Luminotechnic features

- CRI: 90
- MacAdam steps: 2
- Photobiological risk: RG1
- UGR crosswise: 13.1
- UGR lengthwise: 13.1

Lampholder	Quantity	Light source power (W)	Correlated Colour Temperature (CCT)
LED	1	8.9W	LED warm-white 3000K

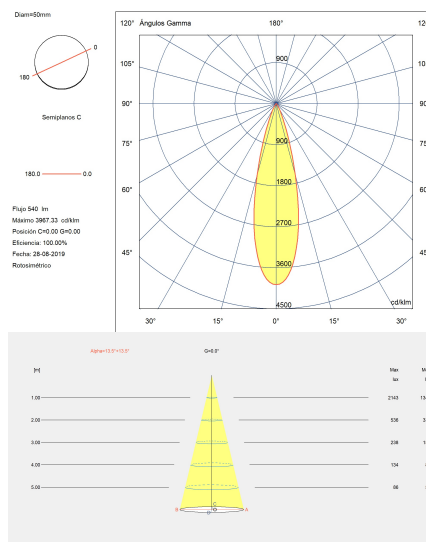
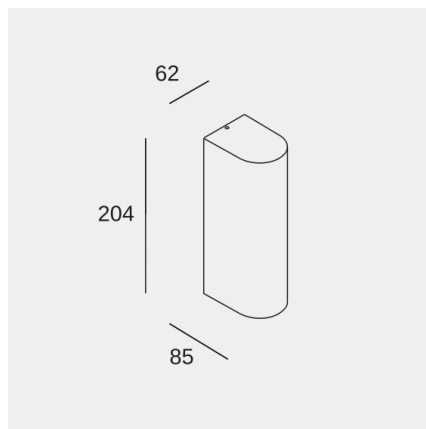

Image may not match reference. LedsC4 reserves the right to amend any of the product's components. The data related to flux, power and colour temperature may be subject to changes made by the manufacturer.



Max Medium Single Emission

LedsC4 Team

Wall fixture IP66 Max Medium Single Emission LED 10.4 LED warm-white 3000K DALI-2 Black 540lm

Logistics

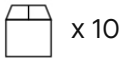

x 10

Net weight (kg): 1.28

Packaged weight (kg): 1.44

Packaging: 100mm x 70mm x 340mm

Image may not match reference. LedsC4 reserves the right to amend any of the product's components. The data related to flux, power and colour temperature may be subject to changes made by the manufacturer.



Max Medium Single Emission

LedsC4 Team

Wall fixture IP66 Max Medium Single Emission LED 10.4 LED warm-white 3000K DALI-2 Black 540lm

Optional accessories

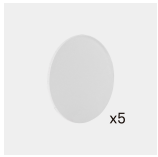

71-E133-00-00

5 filters for producing diffused light

Structure material: Polycarbonate
Dimensions: 40 x NA x 2
Net weight (kg): 0.02

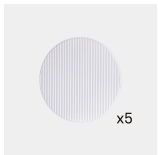

71-E141-00-00

5 filters for producing light in an elliptical shape

Structure material: Polycarbonate
Dimensions: 40 x NA x 2
Net weight (kg): 0.01

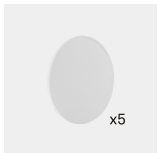

71-E135-00-00

5 filters for producing light in a square shape

Structure material: Polycarbonate
Dimensions: 40 x NA x 1.5
Net weight (kg): 0.02

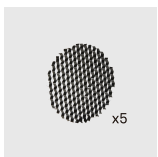

71-E131-00-00

5 honeycomb panels

Structure material: Aluminium
Dimensions: 40 x NA x 3
Net weight (kg): 0.01



71-E463-00-00

Structure material: Methacrylate
Dimensions: 40 x NA x 3
Net weight (kg): 0.02

Image may not match reference. LedsC4 reserves the right to amend any of the product's components. The data related to flux, power and colour temperature may be subject to changes made by the manufacturer.